

**MISCELLANEOUS TUBES**

SQUARE TUBE WITH CORNER RADIUS

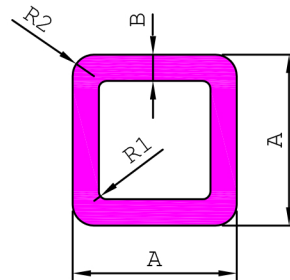

SL. No.	Section No.	A	B	R1	R2	Weight kg/m
1	15226	18.00	2.00	0.40	1.50	0.341
2	15113	19.00	1.50	0.40	1.60	0.277
3	15267	25.00	2.00	4.00	6.00	0.450
4	15228	25.40	1.63	2.40	4.00	0.395
5	15185	32.00	3.00	1.50	3.00	0.924
6	15271	34.00	1.50	2.50	4.00	0.504
7	S5447	35.00	2.00	2.00	4.00	0.685
8	15232	40.00	1.50	0.40	2.00	0.615
9	15251	40.00	2.00	2.00	4.00	0.793
10	15221	44.00	4.00	4.00	4.00	1.728
11	15239	50.80	6.35	3.18	6.35	2.978
12	15220	53.00	4.00	4.00	8.00	2.006
13	S5509	75.00	3.38	0.40	2.00	2.606
14	15252	76.20	4.00	0.50	3.00	3.099
15	15143	101.60	3.18	1.58	4.76	3.333
16	15260	120.00	12.00	5.00	0.40	14.054
17	15282	126.46	2.00	17.48	19.48	2.517
18	15238	150.00	15.00	0.40	2.00	21.861

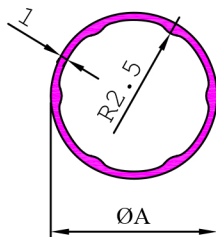

SL No	SECTION No	A	WEIGHT kg/m
1	S5911	22.80	0.201
2	S5912	27.20	0.239
3	S5913	31.60	0.276
4	S5914	36.00	0.314

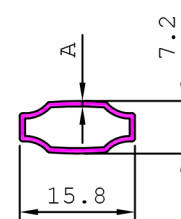

SL No	SECTION No	A	WEIGHT kg/m
1	15121	0.74	0.075
2	15167	0.85	0.087

# TUBES

## MISCELLANEOUS TUBES

### RECTANGULAR TUBE WITH CORNER RADIUS

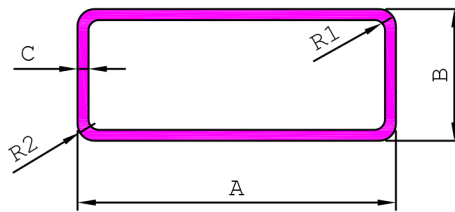

SL. No.	Section No.	A	B	C	R1	R2	Weight kg/m
1	15189	25.00	15.00	3.00	0.40	3.00	0.530
2	15247	30.00	15.00	0.80	1.20	2.00	0.182
3	15230	30.00	18.00	1.20	0.40	1.50	0.290
4	15123	33.00	20.00	1.20	0.40	1.50	0.323
5	15187	33.00	20.00	1.20	1.30	2.50	0.317
6	15256	45.00	20.00	3.00	0.40	3.00	0.935
7	15142	49.80	20.00	1.20	1.30	2.50	0.426
8	15212	49.80	20.00	1.20	1.30	2.50	0.426
9	15258	50.00	25.00	2.00	4.00	6.00	0.720
10	15241	50.80	25.40	2.50	0.40	3.20	0.939
11	S5450	60.00	25.00	1.50	1.50	3.00	0.649
12	15274	62.00	17.00	1.00	3.00	4.00	0.400
13	15249	65.00	24.00	1.20	4.10	5.30	0.535
14	S5508	75.00	25.00	3.38	0.40	2.00	1.693
15	15151	76.20	38.10	4.78	1.00	1.00	2.704
16	15155	80.00	40.00	4.00	2.00	2.00	2.419
17	15207	80.38	41.84	4.56	3.17	0.40	3.201
18	15179	100.00	80.00	2.80	1.20	4.00	2.603
19	15157	120.00	110.00	3.65	2.00	2.00	4.389
20	15186	140.00	120.00	4.00	5.00	9.00	5.313
21	15214	168.00	72.00	4.00	4.00	8.00	4.900
22	15229	245.00	97.00	3.50	0.40	1.00	6.330
23	15264	254.00	89.60	5.00	4.80	9.80	8.838

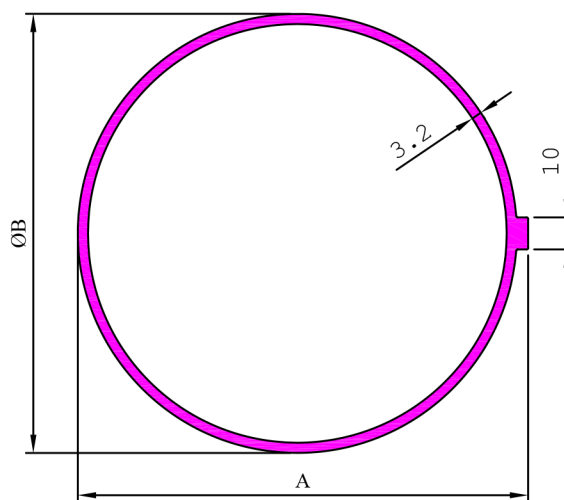

SL. No.	Section No.	A	B	Weight kg/m
1	S6231	141.00	137.50	3.741
2	S6232	159.50	156.00	4.243
3	S6233	178.50	175.00	4.759

# TUBES

## MISCELLANEOUS TUBES

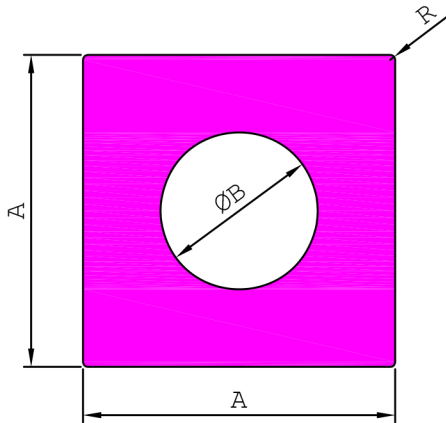

SL No	SECTION No	A	ØB	R	WEIGHT kg/m
1	28111	37.00	17.80	4.00	2.987
2	28100	43.00	24.15	5.00	3.698
3	28101	52.80	32.90	5.50	5.162
4	29425	63.50	32.00	1.00	8.713
5	29432	87.00	44.50	1.00	16.235
6	29042	90.00	70.00	8.00	11.331
7	15213	93.00	48.00	1.00	18.464
8	29362	118.00	68.00	1.00	27.787

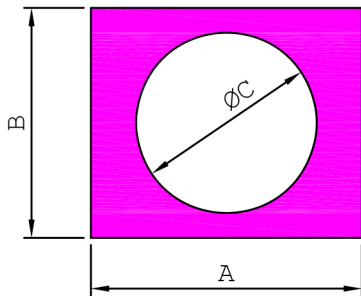

SL No	SECTION No	A	B	ØC	WEIGHT kg/m
1	28735	66.00	56.00	44.00	5.874
2	29610	25.00	20.00	14.00	0.934
3	29592	25.40	24.10	17.00	1.039

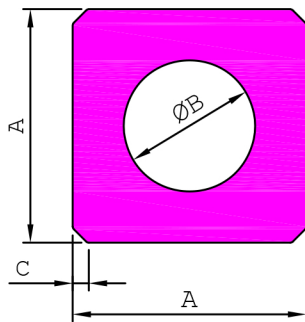

SL No	SECTION No	A	B	Cx45°	WEIGHT kg/m
1	27539	32.00	18.00	2.00	2.066
2	28204	25.00	20.80	2.50	0.736

# TUBES

## MISCELLANEOUS TUBES

29658

45.230 kg/m

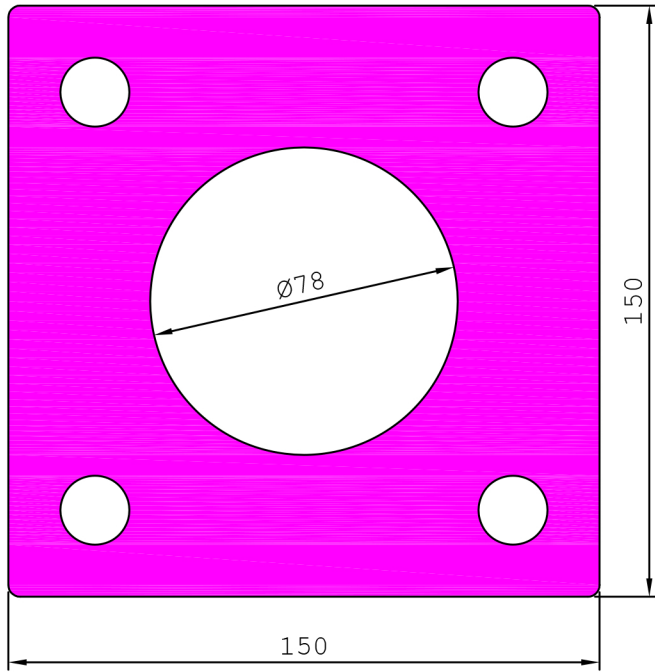

28145

17.018 kg/m

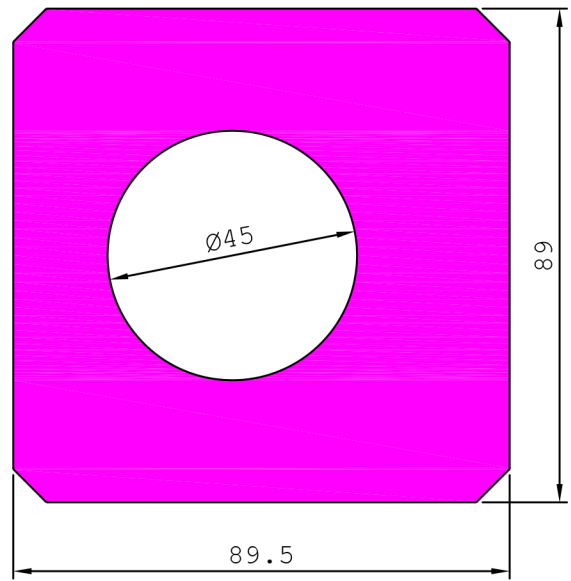

29659

27.049 kg/m

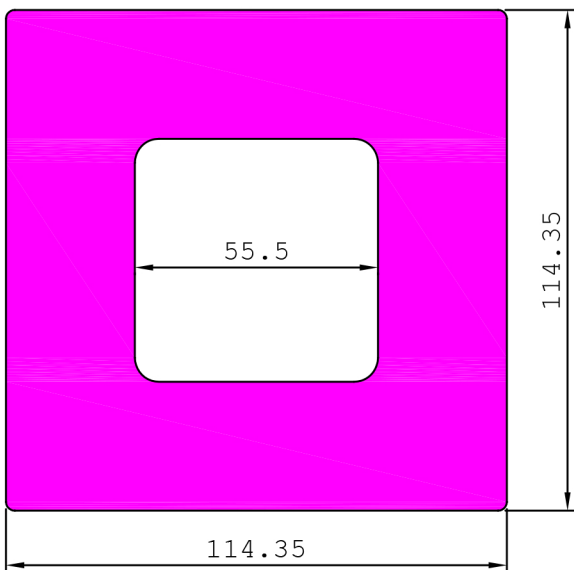

S6347

2.843 kg/m

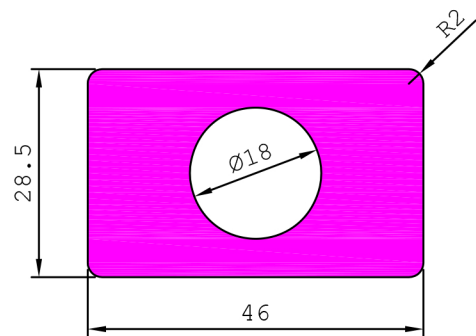

**MISCELLANEOUS TUBES**

15118

1.570 kg/m

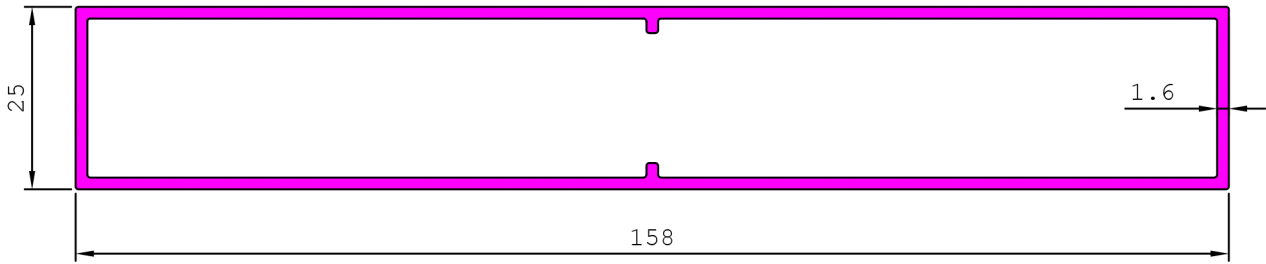

15136

0.137 kg/m

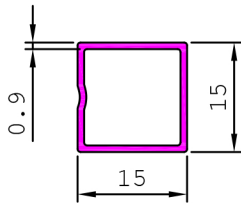

15203

0.391 kg/m

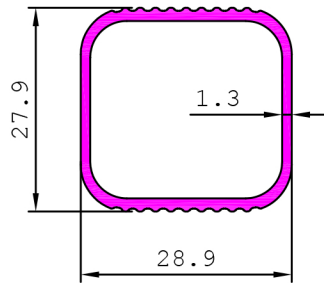

15286

0.572 kg/m

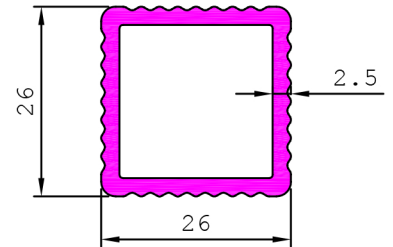

15145

4.780 kg/m

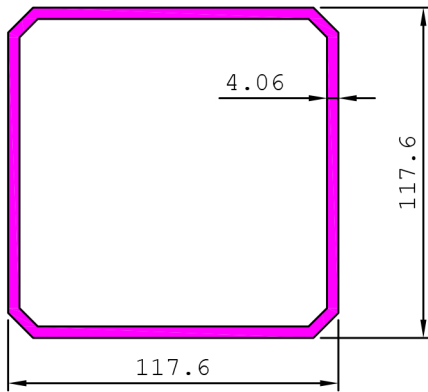

15175

2.894 kg/m

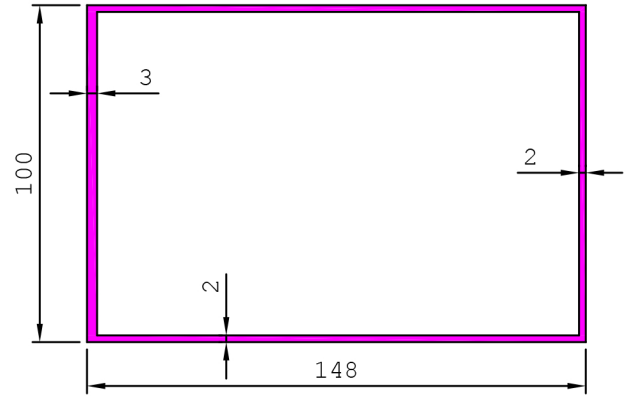

15135

0.869 kg/m

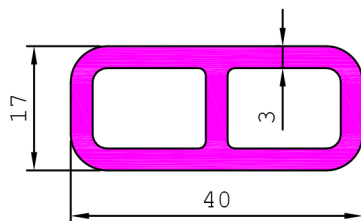

15218

1.350 kg/m

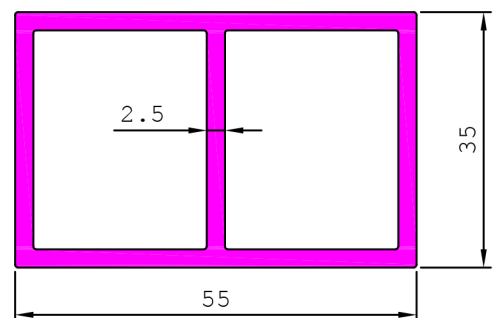

# TUBES

## MISCELLANEOUS TUBES

15202

0.695 kg/m

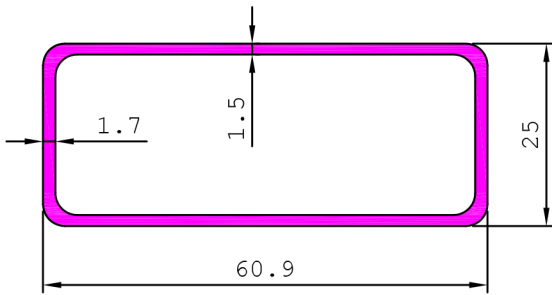

15205

0.944 kg/m

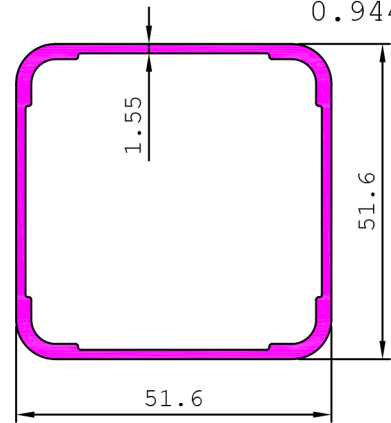

15206

1.119 kg/m

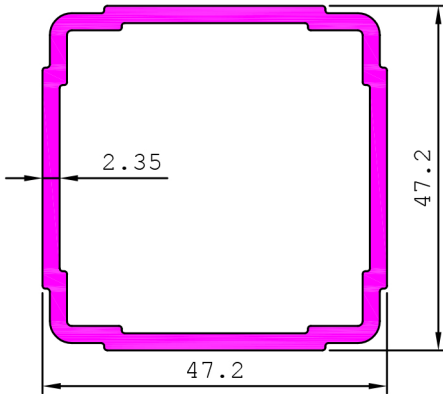

15210

7.375 kg/m

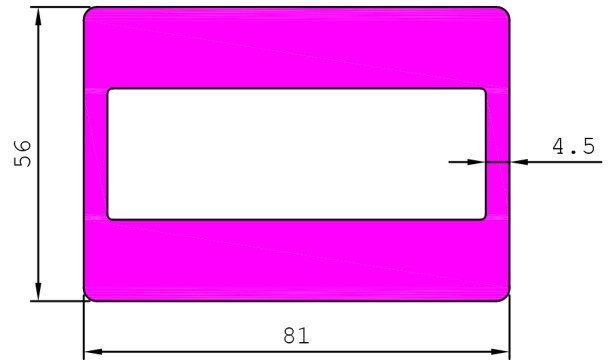

15180

4.780 kg/m

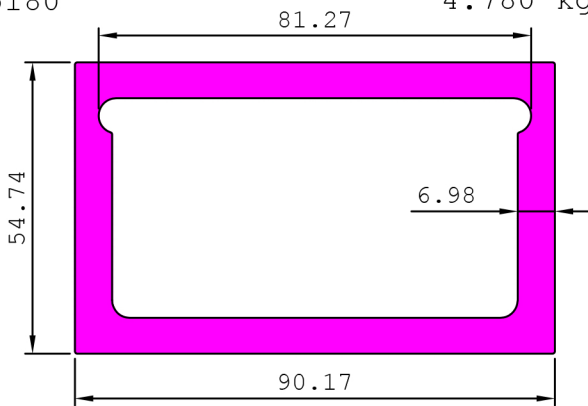

15225

1.501 kg/m

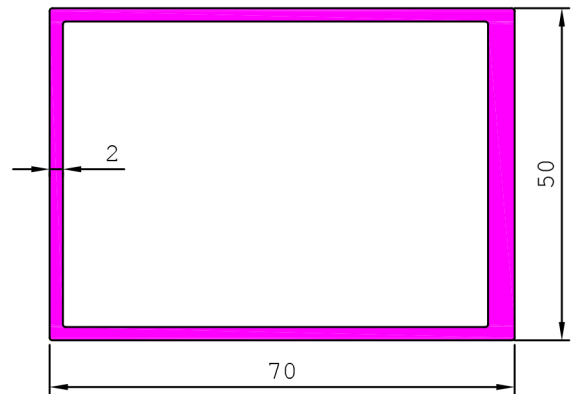

15259

5.104 kg/m

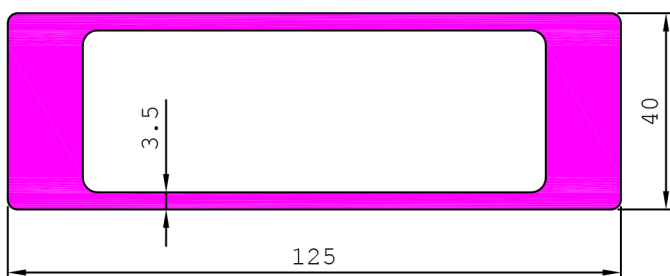

15261

2.887 kg/m

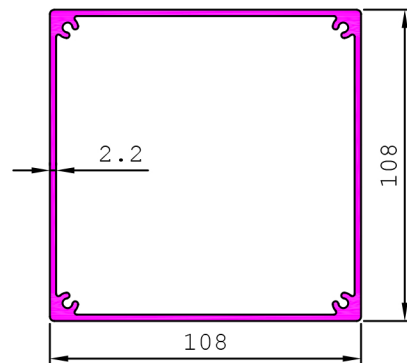

**MISCELLANEOUS TUBES**

15222

0.962 kg/m

15224

0.852 kg/m

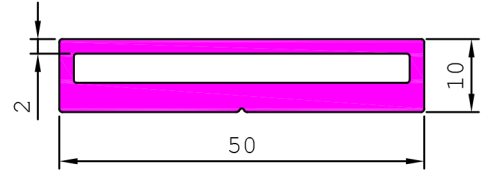
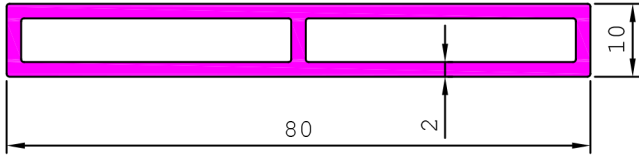

15227

2.676 kg/m

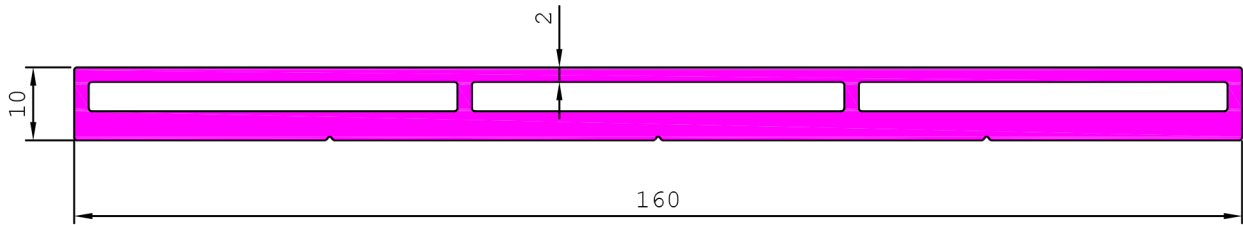

15240

0.504 kg/m

15257

0.761 kg/m

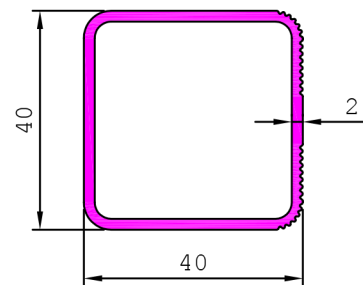
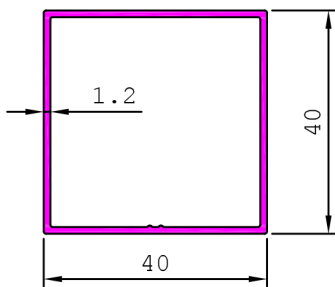

15265

7.107 kg/m

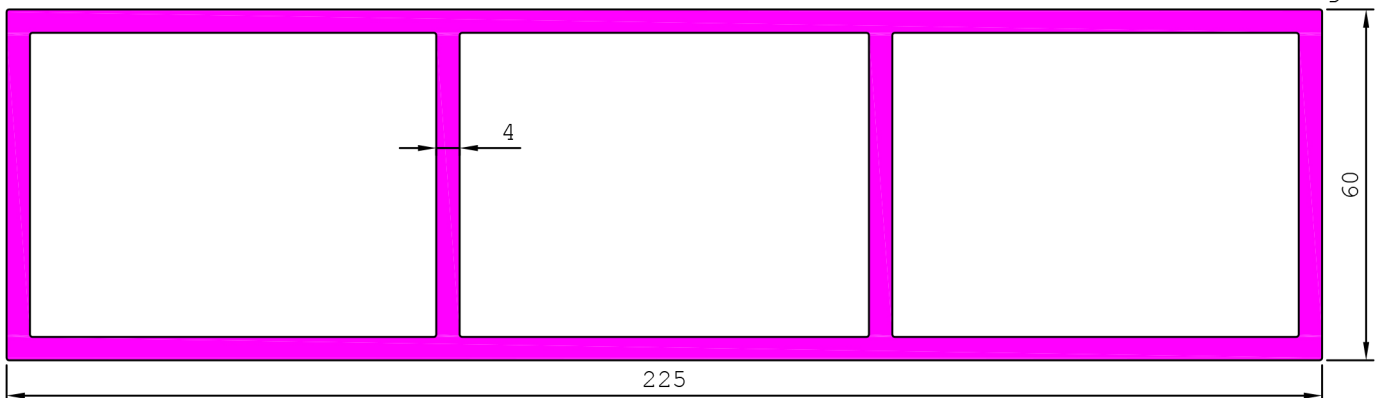

# TUBES

## MISCELLANEOUS TUBES

15269

2.564 kg/m

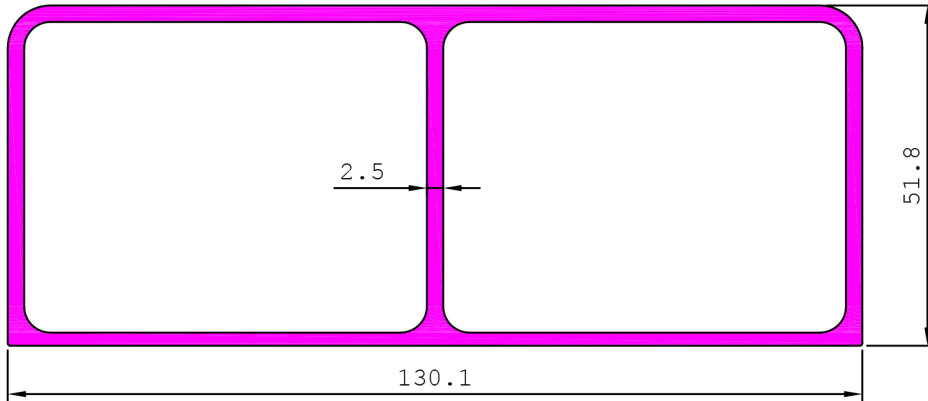

15273

0.615 kg/m

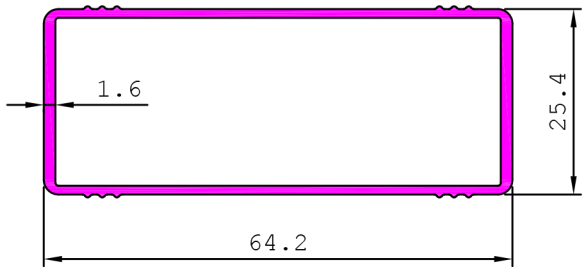

S5448

0.789 kg/m

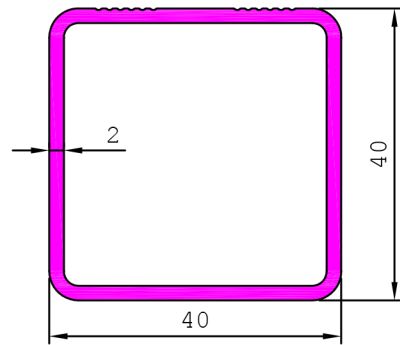

S5449

0.523 kg/m

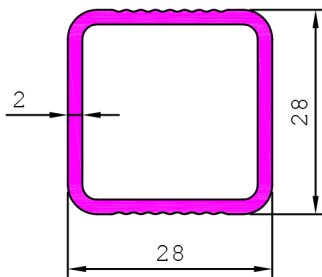

15275

0.326 kg/m

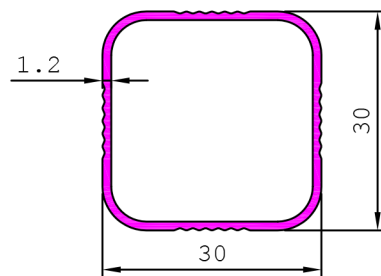

15284

0.719 kg/m

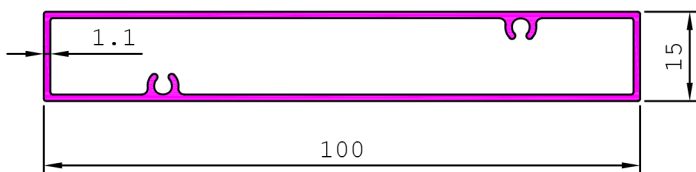

S6380

0.458 kg/m

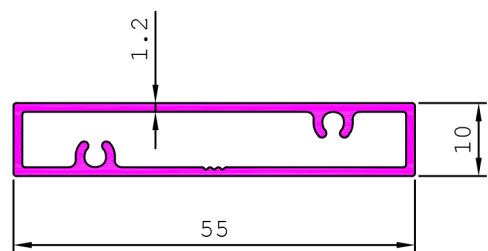



## MISCELLANEOUS TUBES

15288

5.125 kg/m

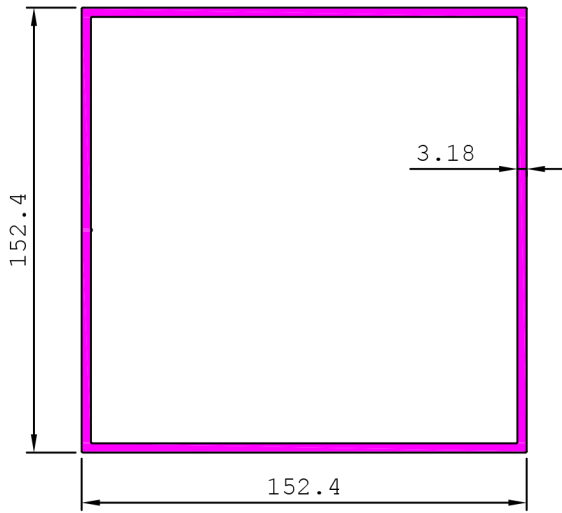

15289

0.721 kg/m

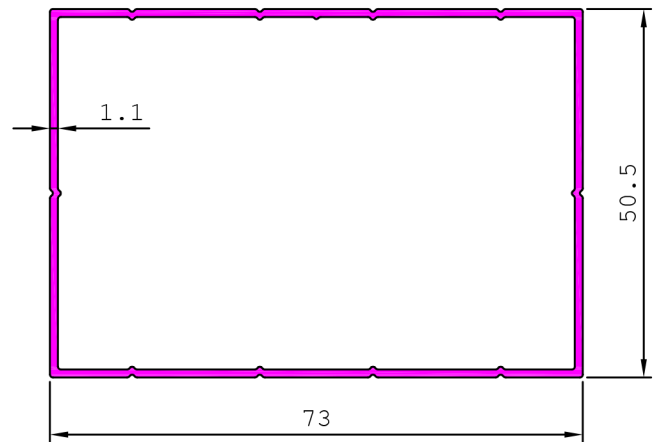

S5752

5.474 kg/m

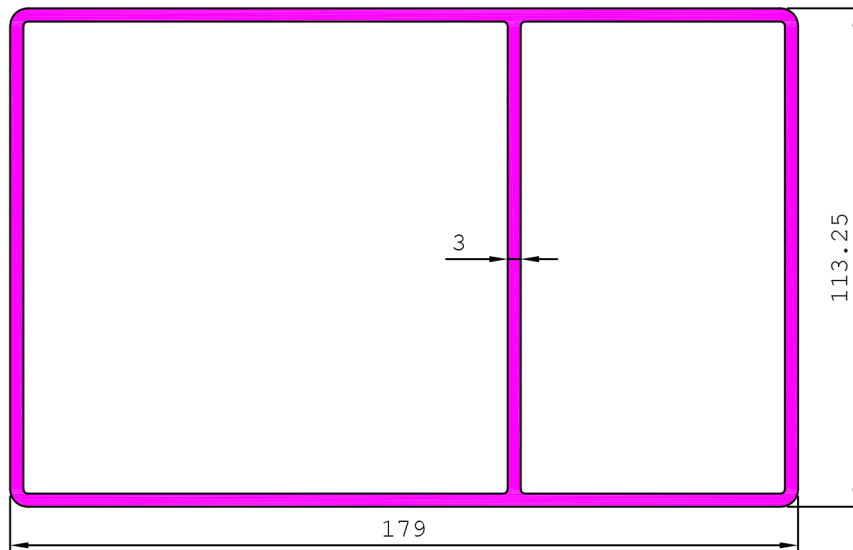

15285

0.516 kg/m

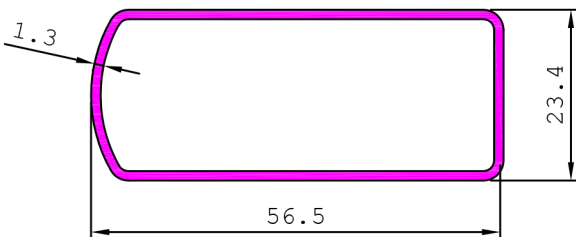

S6164

3.188 kg/m

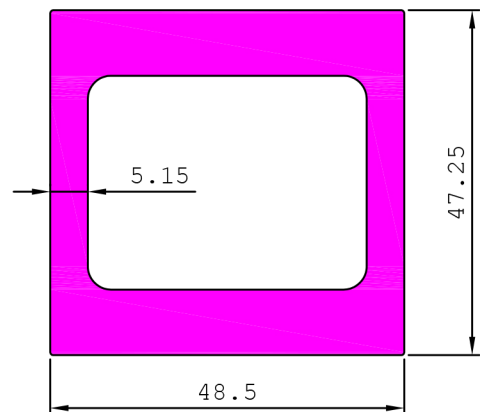

**MISCELLANEOUS TUBES**

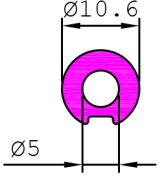
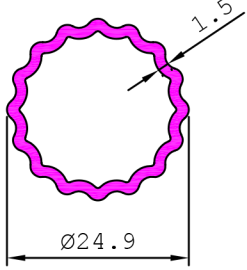
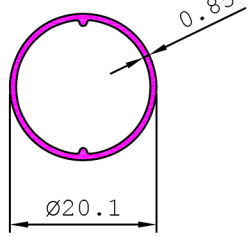
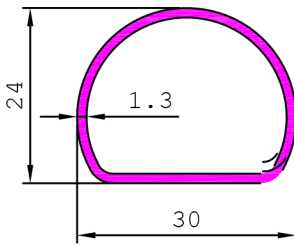
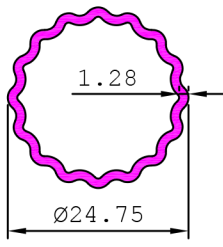
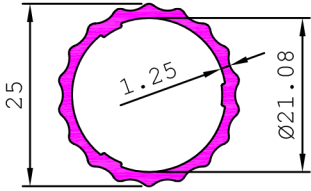
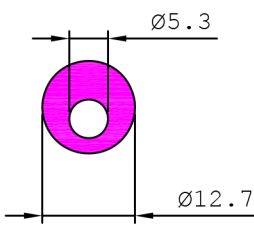
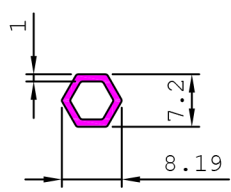
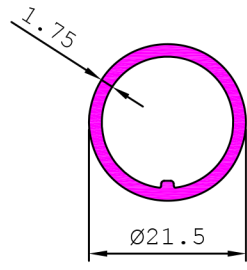
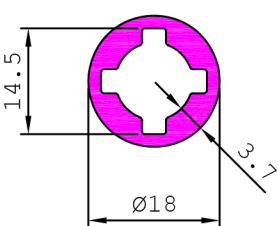
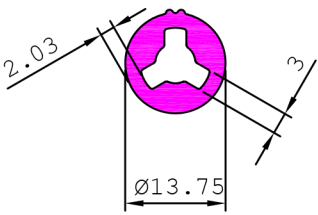
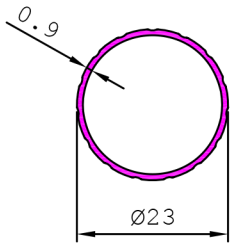
<p>15237      0.172 kg/m</p> 	<p>15250      0.322 kg/m</p> 	<p>S5754      0.143 kg/m</p> 
<p>15150      0.300 kg/m</p> 	<p>15152      0.271 kg/m</p> 	<p>15163      0.310 kg/m</p> 
<p>15176      0.282 kg/m</p> 	<p>15190      0.058 kg/m</p> 	<p>15223      0.298 kg/m</p> 
<p>15204      0.377 kg/m</p> 	<p>15215      0.287 kg/m</p> 	<p>15236      0.161 kg/m</p> 

# TUBES

## MISCELLANEOUS TUBES

15101

1.230 kg/m

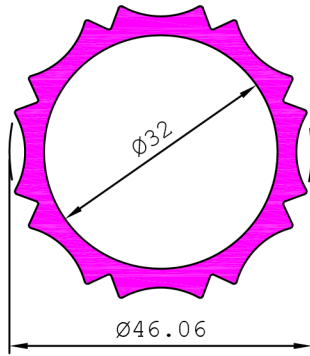

15130

0.621 kg/m

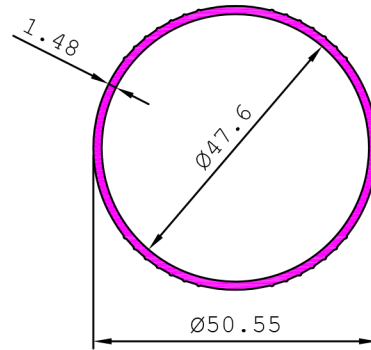

15156

0.329 kg/m

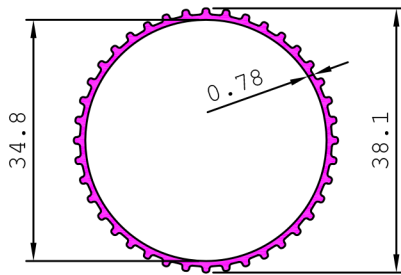

15199

0.700 kg/m

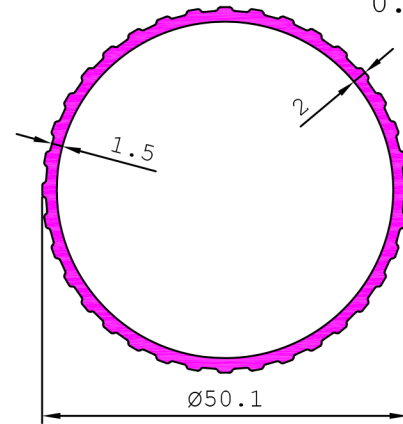

15242

1.350 kg/m

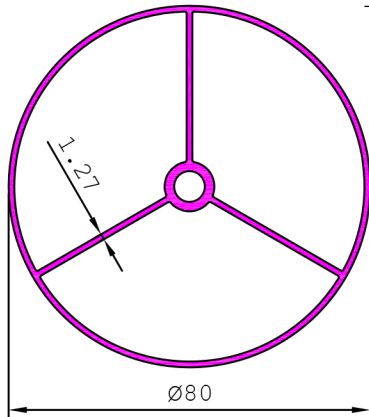

15248

1.768 kg/m

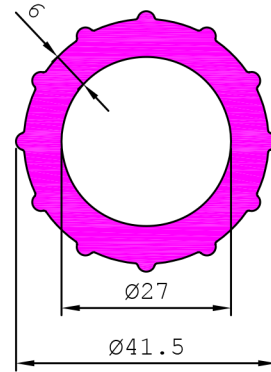

29608

1.212 kg/m

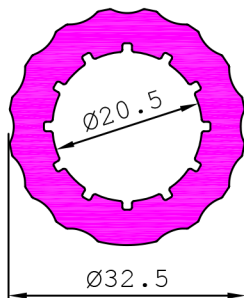

15270

1.881 kg/m

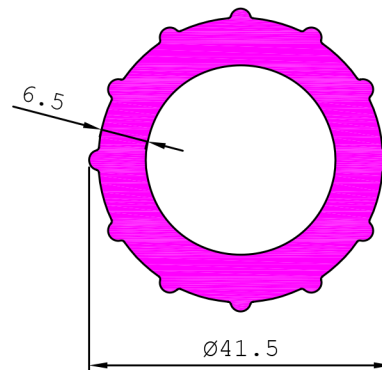

**MISCELLANEOUS TUBES**

15216 69.928 kg/m

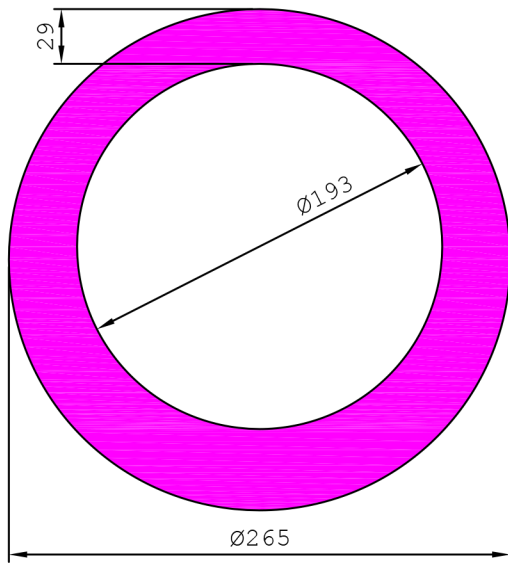

15219 1.509 kg/m

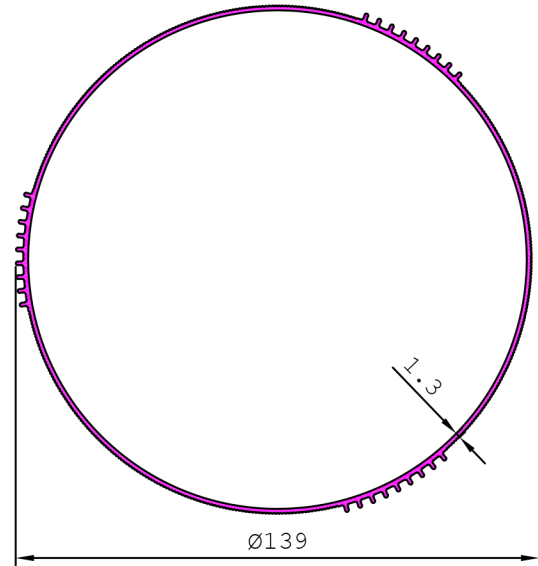

15244 81.729 kg/m

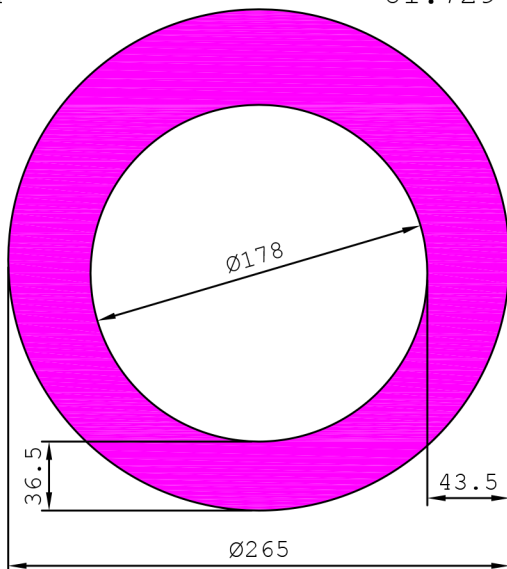

15253 0.738 kg/m

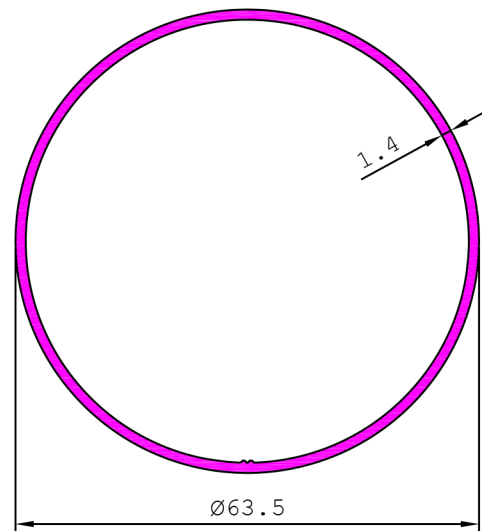

15263 2.330 kg/m

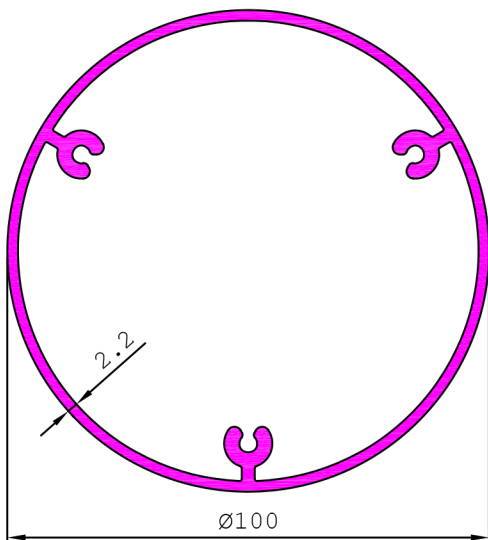

15268 0.846 kg/m

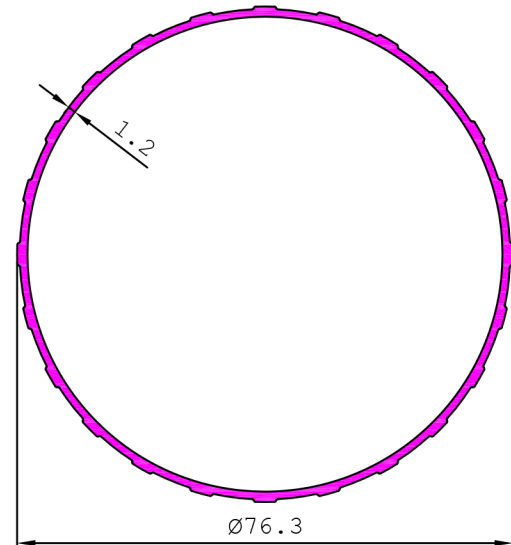

**MISCELLANEOUS TUBES**

S5989

0.452 kg/m

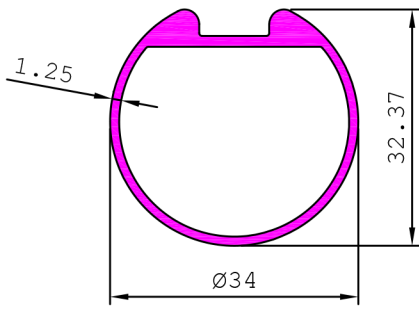

15283

2.058 kg/m

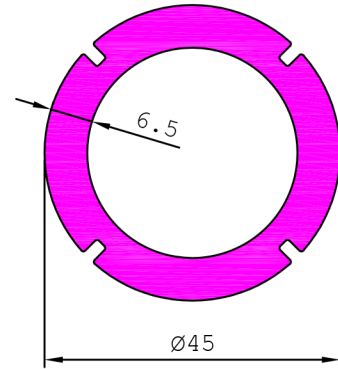

S5941

0.205 kg/m

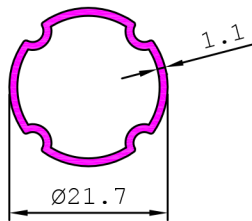

S5942

0.304 kg/m

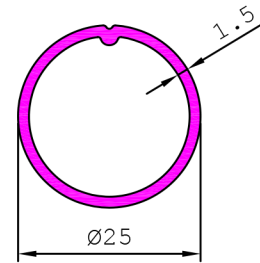

MATCHING WITH S5942

MATCHING WITH S5941

15287

0.860 kg/m

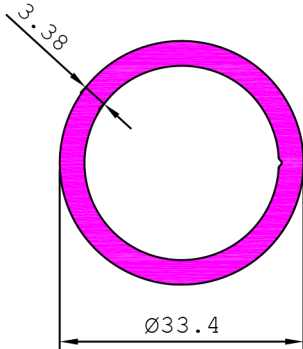

S6309

7.327 kg/m

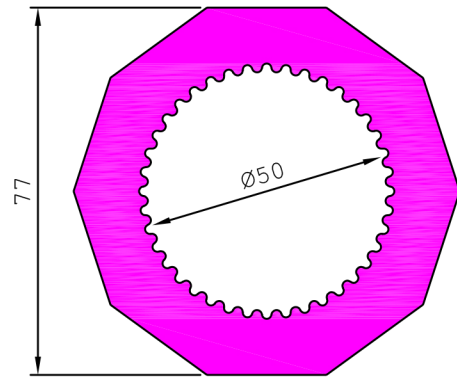

# TUBES

## MISCELLANEOUS TUBES

15117 4.478 kg/m

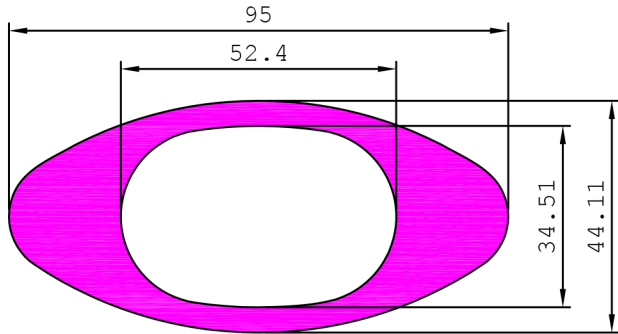

15125 1.111 kg/m

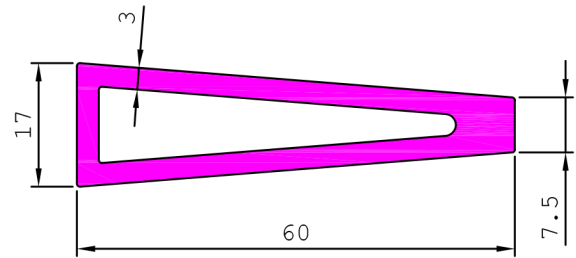

15109 0.460 kg/m

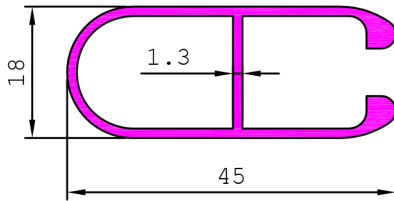

15233 0.307 kg/m

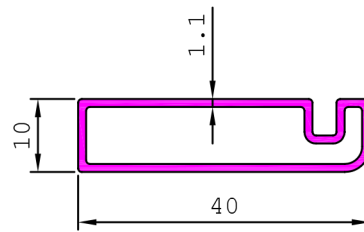

15234 0.488 kg/m

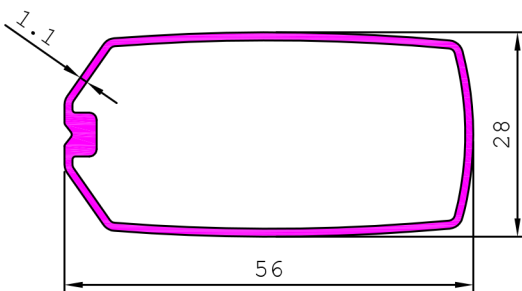

15235 0.333 kg/m

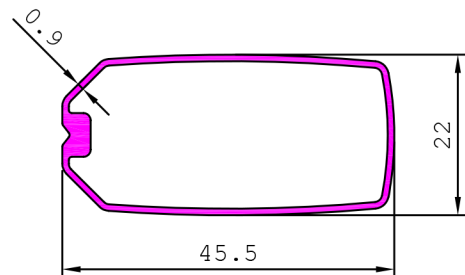

15246 0.488 kg/m

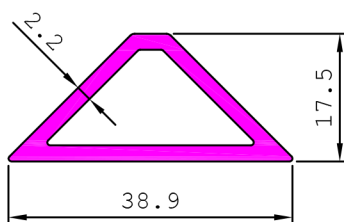

15243 0.207 kg/m

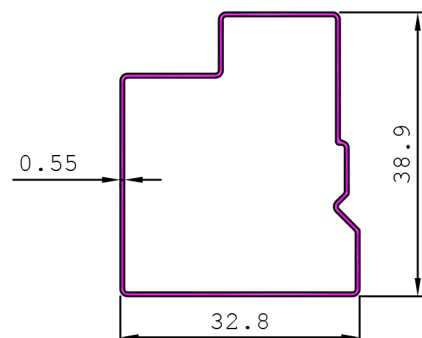

# TUBES

Authorized Dealer

## MISCELLANEOUS TUBES

15262

0.330 kg/m

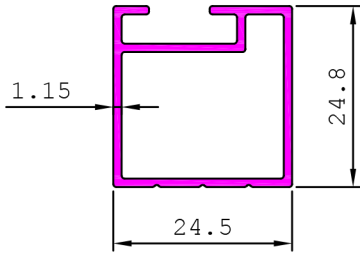

15281

0.333 kg/m

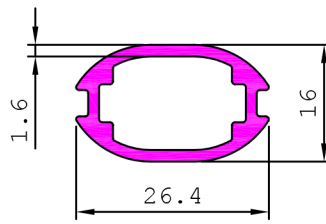

15272

0.184 kg/m

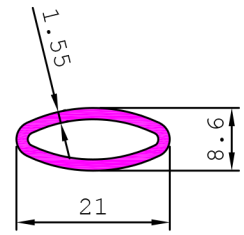

15254

0.153 kg/m

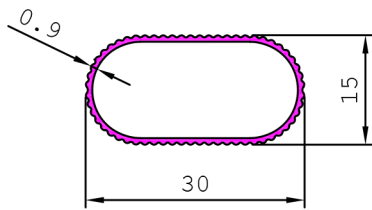

15255

0.175 kg/m

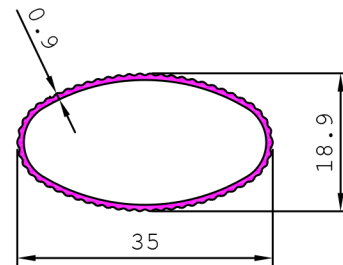

15277

1.421 kg/m

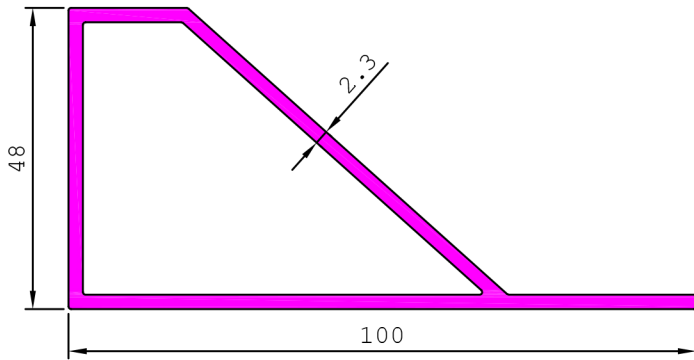

15278

1.017 kg/m

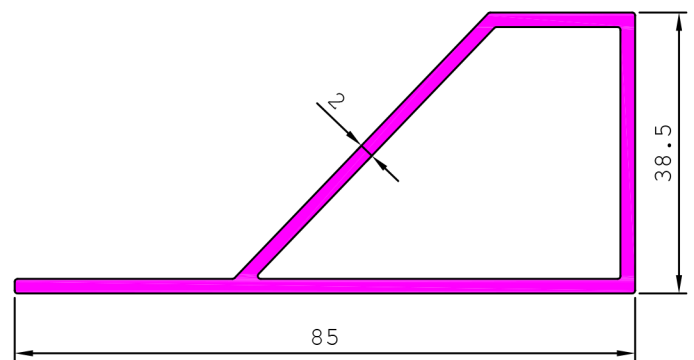

15279

0.833 kg/m

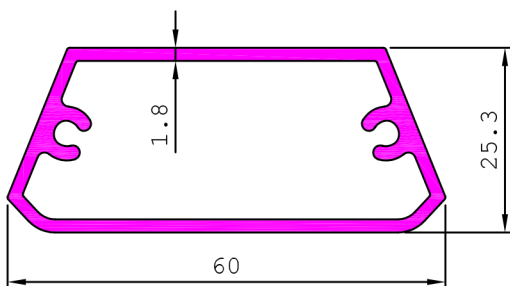

15280

0.280 kg/m

